

Übergangsstücke für Stickstoffflaschen



OLAER Austria GmbH
 Wachtelstrasse 25, A – 4053 Haid
 Tel. ..43 (7229) 803 06
 Fax ..43 (7229) 803 06 - 21
 E-mail: info@olaer.at www.olaer.at

Länderliste OSP 750

Land	Vorschlag	Ebenfalls möglich
Ägypten	40 b	40 h
Algerien	40 h	
Argentinien	40 b	
Armenien	40 n	38 *
Aserbaidschan	40 n	38 *
Äthiopien	40 b	
Australien	40 p	
Bahamas	40 b	
Bahrain	40 h	
Bangladesch	40 b	
Barbados	40 b	
Belgien	38 *	40 h
Bolivien	40 g	
Bosnien Herzegowina	40 h	
Botswana	40 b	
Brasilien	40 g	
Bulgarien	40 n	40 h
Burma	40 b	
Chile	40 g	
China	40 k	40 i
Costa Rica	40 b	
Dänemark	38 *	
Deutschland	38 *	
Dom. Republik	40 g	
Dschibuti	40 h	
Ecuador	40 g	
Elfenbeinküste	40 h	
Fidschi	40 b	
Finnland	38 *	
Frankreich	40 h	
Gabun	40 h	
Gambia	40 b	
Georgien	40 n	38 *
Ghana	40 b	
Griechenland	40 h	40 b
Grossbritannien	40 b	
Guatemala	40 g	
Guinea	40 h	
Guyana	40 g	
Honduras	40 g	
Hongkong	40 b	

Land	Vorschlag	Ebenfalls möglich
Indien	40 b	
Indonesien	40 b	
Irak	40 h	
Iran	40 h	
Irland	40 b	
Israel	40 h	
Italien	40 d	
Jamaika	40 b	
Japan	40 e	40 f
Jordanien	40 h	
Kanada	40 c	
Kasachstan	40 n	38 *
Katar	40 h	
Kenia	40 b	
Kirgisistan	40 n	38 *
Kolumbien	40 g	
Korea	40 f	
Kosovo	40 h	
Kroatien	40 h	
Kuwait	40 h	
Libanon	40 h	
Libyen	40 h	
Liechtenstein	38 *	
Luxemburg	38 *	
Malawi	40 b	
Malaysia	40 l	40 b
Malta	40 b	
Marokko	40 h	
Mauritius	40 h	
Mazedonien	40 h	
Mexiko	40 h	
Moldau	40 n	38 *
Montenegro	40 h	
Mozambique	40 h	
Neuseeland	40 b	
Niederlande	38 *	
Nigeria	40 h	
Norwegen	38 *	
Oman	40 h	
Österreich	38 *	
Pakistan	40 b	

Land	Vorschlag	Ebenfalls möglich
Paraguay	40 g	
Peru	40 g	
Philippinen	40 b	40 o
Polen	38 *	
Portugal	40 b	
Puerto Rico	40 c	
Rumänien	40 h	
Russland	40 n	38 *
Sambia	40 b	
Saudi-Arabien	40 h	40 b
Schweden	38 *	
Schweiz	38 *	
Serbien	40 h	
Singapur	40 b	
Slowakei	38 *	
Slowenien	38 *	
Spanien	40 h	
Sri Lanka	40 b	
Süd-Afrika	40 b	
Sudan	40 b	
Surinam	40 b	
Swasiland	40 b	
Syrien	40 h	
Taiwan	40 b	40 i
Tansania	40 b	
Thailand	40 b	
Trinidad / Tobago	40 m	40 n
Tschetschenien	38 *	
Tschechien	38 *	
Tunesien	40 h	
Türkei	40 b	38 *
Turkmenistan	40 n	38 *
Ukraine	38 *	
Ungarn	40 h	
Uruguay	40 g	
USA	40 c	
Usbekistan	40 n	38 *
Venezuela	40 n	
Vereinigte Emirate	40 h	
Vietnam	40 b	
Weissrussland	40 n	38 *
Zypern	40 b	

38 * Anschluss am Prüf- und Füllgerät enthalten (W24, 32 x 1¼ ")

Fabrikationstoleranzen sind nicht berücksichtigt

Konstruktionsänderungen vorbehalten

Raccorde

38 entspricht TS 3

Ref 202150 - 00000

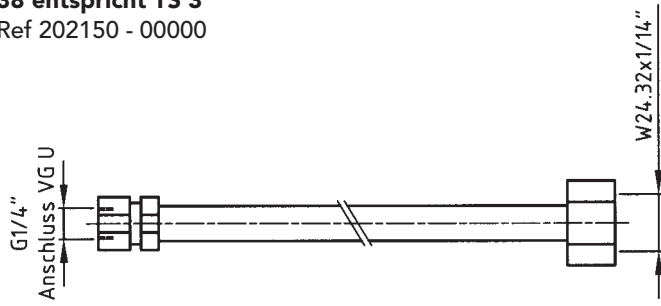

40 b

Ref 993507-02800

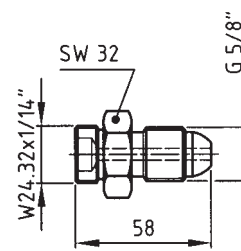

40 c

Ref 993508-02800

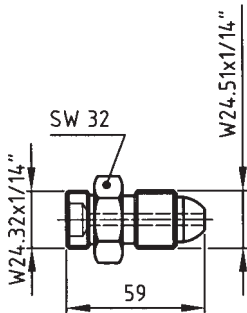

40 d

Ref 993509-02800

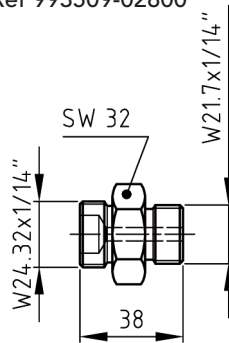

40 e

Ref 993510-02800

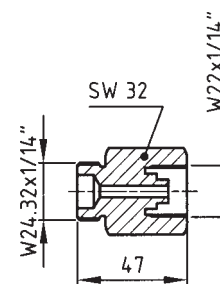

40 f

Ref 993511-02800

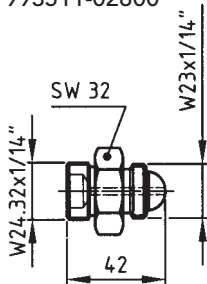

40 g

Ref 993512-02800

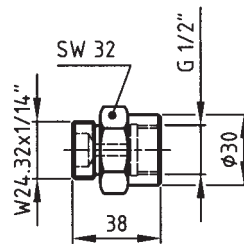

40 h

Ref 993513-02800

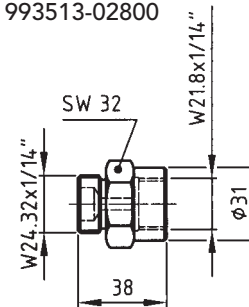

40 i

Ref 993514-02800

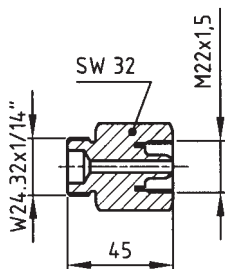

40 k

Ref 993520-02800

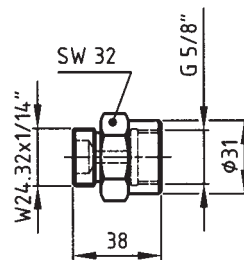

40 l

Ref 993518-02800

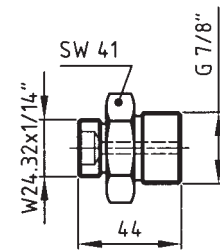

40 m

Ref 993519-02800

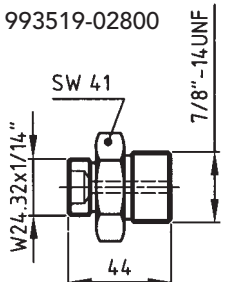

40 n

Ref 993524-02800

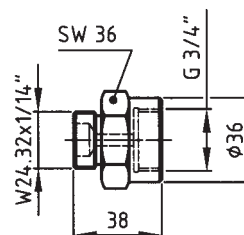

40 o

Ref 993525-02800

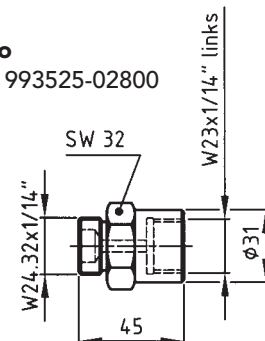

Raccorde

40 p
Ref 993548-02800

